

Identification

Type Designation	LR3 48-5/160	Type of reactor	3~ Line Reactor
Series	LR3	Core Rating	6659.17 var
Core type	3UI 150/52	Drive HP	125

Technical Data

No. of phase		3
Circuit type		III0
Rated Voltage	[V]	480
Rated current	[A]	160.0
Rated Frequency	[Hz]	50 - 60
Impedance	[%]	5.0
Inductance L	[mH]	0.230
L tolerance	[%]	±10%
Linearity		150% In
Losses (typical)	[W]	145.20
Test voltage	[kV]	4.0
Isolation System Class		class 180

Operating conditions

Ambient temperature	[°C]	-10 ... +40°C
Ambient temperature	[F]	14 ... 104°F
Type of cooling		AN
Operating conditions		24/7

Standards

Type:	Signs
VDE 0570 / EN 61 558 Part 1 VDE 0570 / EN 61 558 Part 20	

Approvals

UL 508		E219022	NMTR
UL 5085-1		E103521	XPTQ

Product Ident
LR3 48-5/160

Line-Reactor Datasheet



Variations may apply due to material's and production's tolerances. Objected to modifications without notice.

Dimensions / Mounting in Inches

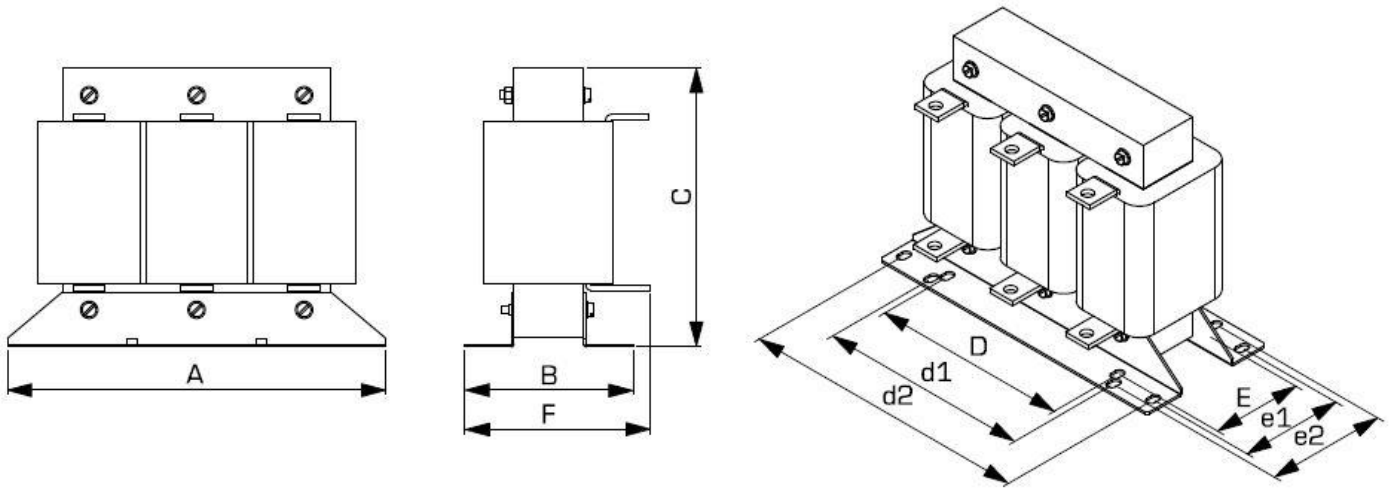

A	B	C*	F	D	d1	d2	E	e1	e2	Drill
13.86	6.54	10.39	-	8.82	9.45	12.90	3.82	4.84	4.20	0.39
										0.39
										0.39

* = Typical variable air gab

Weight

Weight	[kg]	36.19
	[lbs]	79.78

Notes

Technical specifications in the drawing are not binding. General tolerance to DIN 7168-m. Subject to change.
Mounting plates also available in stainless steel as OEM application. Ask for details.

Original Date:	15/04/20	Observe protection clause to ISO 16016	Index	0
Name:	Lüning		Doc. type	
Date:	15/05/06			
Checked:	Wesner		Pages	2 of 2